

5925242 JUN 2017

Manufacturer's statement

Read this operation manual carefully before use to ensure proper operation of this product. Failure to read this operation manual may cause improper operation and may result in serious injury or death of a person. The meanings of the symbols are as follows.

	WARNING	Failure to follow the instructions provided with this indication and improper handling may cause death or serious injury.
	CAUTION	Failure to follow the instructions provided with this indication and improper handling may cause injury and/or property damage.
	NOTE	Special attention is required to the section of this symbol.

- NOTE**
- This product is a non-contact switch intended for header mount for use on industrial door. Do not use for any other applications.
 - When setting the sensor's detection area, make sure that there is no traffic around the installation site.
 - Before turning the power ON, check the wiring to prevent damage or malfunction of equipment connected to the product.
 - Only use the product as specified in the operation manual provided.
 - Be sure to install and adjust the sensor in accordance with the local laws and standards of the country in which the product is installed.
 - Before leaving the installation site make sure that the product is operating properly and instruct the building owner/operator on proper operation of the door and the product.
 - The product settings can only be changed by an installer or service engineer. When changed, the changed settings and the date shall be registered in the maintenance logbook accompanying the door.

	WARNING	Do not wash, disassemble, rebuild or repair the sensor, otherwise it may cause electric shock or breakdown of the equipment.
Danger of electric shock.		

- NOTE** The following conditions are not suitable for sensor installation.
- Fog or exhaust emission around the door.
 - Wet floor.
 - Vibrating header or mounting surface.
 - Moving objects or objects that emit light near the detection area.
 - Highly reflecting floor or highly reflecting objects around the door.



Specifications

Model	: OA-6500S T	Activation output	: 3rd row detection N.C. / N.O. selectable 50V 0.3A MAX.(Resistance load)
Color	: Black	Test input	: Opto coupler Voltage 5 to 30VDC Current 6mA Max. (30VDC)
Mounting height	: 8'2" (2.5m) to 21'4" (6.5m)	Safety output	: 1st or 2nd row detection N.C. / N.O. selectable 50V 0.3A MAX.(Resistance load)
Detection area	: See Detection area	Output hold time	: Approx. 0.5sec.
Detection method	: Active infrared reflection method (All presence detection)	Response time	: < 0.3sec.
Depth adjustment	: 1st and 2nd rows: -15° to +5° 3rd row: +30° to +50°	Operating temperature	: -4°F to 131°F (-20°C to +55°C)
Power supply	: 12 to 24VAC ±10% (50 / 60Hz) 12 to 30VDC ±10%	Operating humidity	: < 80%
Power consumption	: < 2.5W (< 3.5VA at AC)	IP rate	: IP44
Operation indicator	: Green / Stand-by Red / 1st row detection Orange / 2nd and 3rd rows detection	Weight	: 21.2 oz (600g)
		Accessories	: 1 Cable 25' (7.62m) 2 Mounting screws 1 Mounting template 1 Operation manual 1 High mount window 1 Protection sticker

NOTE The specifications herein are subject to change without prior notice due to improvements.

NOTE LED will be turned off about 500ms when the sensor Test output signal works well.

Detection area

[Standard window]

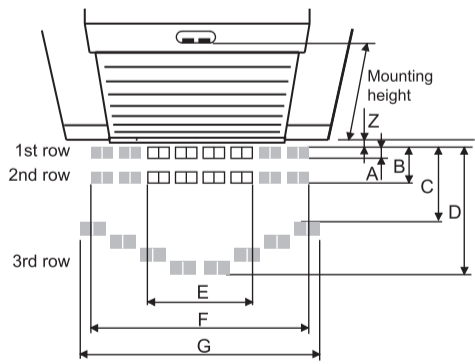

- : Emitting spots
- : Emitting spots (Can be eliminated)

[High mount window]

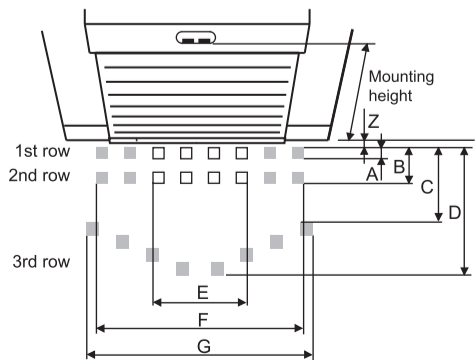

- : Emitting spots
- : Emitting spots (Can be eliminated)

Window	Standard window			High mount window	
	8'2" (2,500)	11'6" (3,500)	14'9" (4,500)	18'1" (5,500)	21'4" (6,500)
A	6" (150)	8" (210)	11" (280)	11" (340)	14" (400)
B	1'10" (560)	2'7" (790)	3'4" (1010)	4'1" (1240)	4'10" (1470)
C	2'3" (680)	3'2" (960)	4'1" (1240)	4'11" (1510)	5'11" (1790)
D	4'5" (1340)	6'2" (1870)	7'11" (2410)	9'8" (2940)	11'5" (3480)
E	5'1" (1530)	7'1" (2150)	9'1" (2760)	9'2" (2790)	10'10" (3300)
F	11'11" (3640)	16'9" (5100)	21'7" (6560)	23'9" (7230)	28'1" (8550)
G	12'7" (3840)	17'8" (5380)	22'8" (6910)	25' (7620)	29'7" (9010)
Z	6" (150)	9" (220)	11" (280)	11" (340)	14" (410)

Values of the chart are based on the following depth angle adjustment settings;
1st and 2nd rows : +5°
3rd row : +30°

NOTE

The actual detection area may become smaller depending on the ambient light, the color / material of the object or the floor as well as the entry speed of the object.
The sensor may not be activated when the entering speed of the object or a person is slower than 50mm / sec. or faster than 1500mm / sec.

Installation

- Drill two mounting holes $\phi 1/8"$ ($\phi 3.4\text{mm}$) on the header. To pass the cable through the header, drill a wiring hole of $\phi 5/16"$ ($\phi 8\text{mm}$).

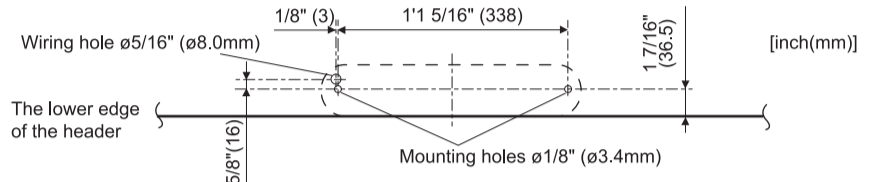

- Wire the cable to the door controller as shown below.

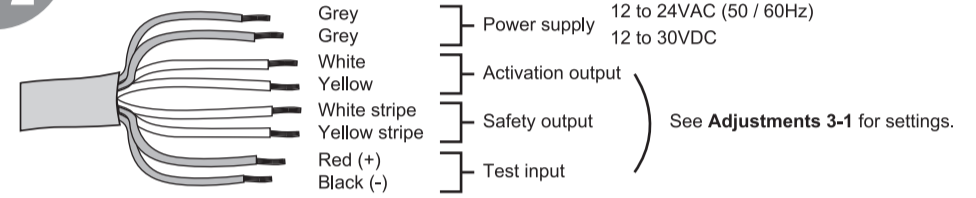

	WARNING	Before starting the procedure, make sure that the power is turned OFF. When passing the cable through the hole, do not tear the shield. otherwise it may cause electric shock or breakdown of the sensor.
Danger of electric shock.		

- Plug the connector of the sensor.
- Supply power to the sensor. Adjust the detection area and set the dipswitches. (See **Adjustments**)

NOTE Make sure to connect the cable correctly to the door controller before turning the power ON. When turning the power ON or after adjusting the settings, do not enter the detection area for more than 10 seconds in order to enable the presence detection. When changing the settings of dipswitch, see **Adjustments 3 Dipswitch settings**.

- Put the protection sticker as shown below.

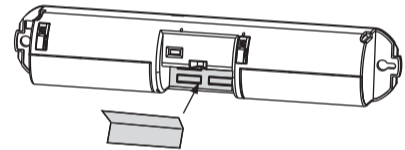

- Place the housing cover. If wiring is to be exposed, break the knockout.

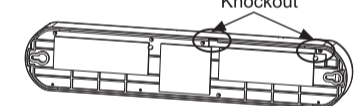

	WARNING	Do not use the sensor without the cover. When using the cable knockout, install the sensor indoors or use the rain-cover (Separately available) otherwise electric shock or breakdown of the sensor may occur.
Danger of electric shock.		

Adjustments

1 Detection window selection

According to the mounting height, select proper detection window.

- 8'2"(2.5m) to 16'5"(5.0m) : Standard window(default)
- 16'5"(5.0m) to 21'4"(6.5m) : High mount window

When changing window follow procedure below.

- Remove the screws

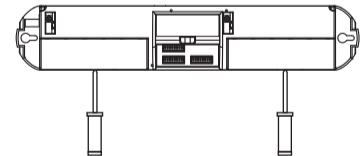

- Take the windows off.

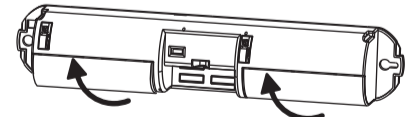

- Attach the windows.

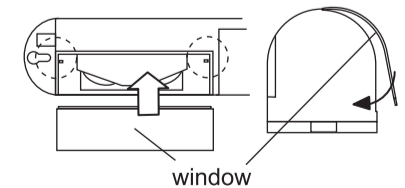

- Fix the windows with the screws.

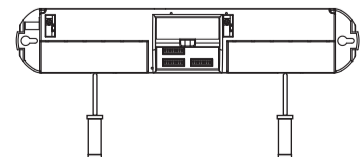

NOTE Please carry out operation check after changing window.

Adjustments

2 Area adjustment

[Depth adjustment]

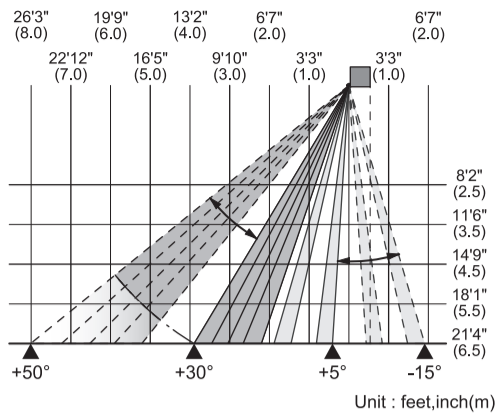
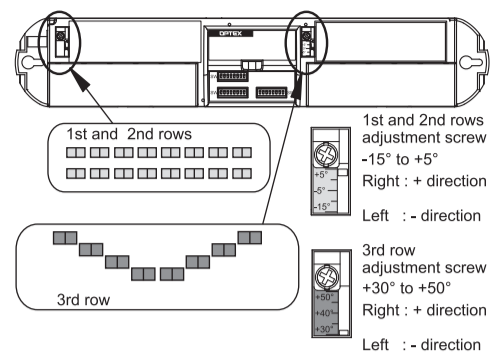

[Right and left elimination]



1st and 2nd rows

Detection areas 1 to 4 shown in right figure can be eliminated with dipswitches 1 to 4.
*Detection area 2 (3) can not be eliminated when dipswitch 1 (4) is not eliminated.

3rd row

Detection areas 5 to 8 can be eliminated with dipswitches 5 to 8.

Detection areas 1 to 8 correspond to dipswitches 1 to 8

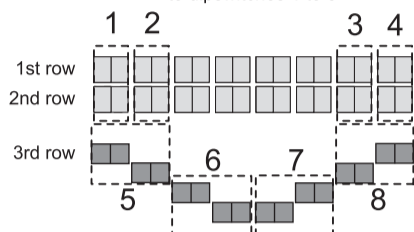

3 Dipswitch settings

[1. Dipswitches <SW1>]

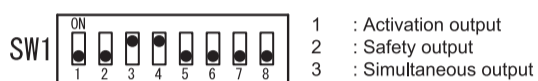

3-1. Setting the Outputs (SW1 Dipswitch 1,2,3 and 4)

The outputs from Activation output (2nd and 3rd rows) and Safety output (1st row) can be selected separately from N.C. and N.O. by dipswitch 1 and 2.

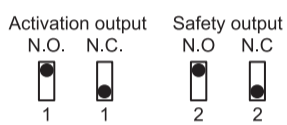

The output timing from "Activation output" and "Safety output" can be changed by dipswitch 3. With dipswitch 3 set to "ON" the output timing will be the same. With dipswitch 3 set to "OFF" the output timing will be different. See **Checking**.

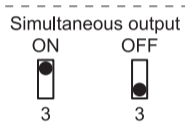

The 2nd row output selectable by dipswitch 4. With dipswitch 4 set to "ON" the output from 2nd row will be sent from Activation output. With dipswitch 4 set to "OFF" the output will be sent from Safety output. See **Checking**.

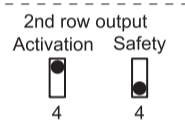

3-2. Setting the Frequency (SW1 Dipswitch 6 and 7)

When using more than one sensor close to each other, set the different frequency for each sensor by combining dipswitch 6 and 7.

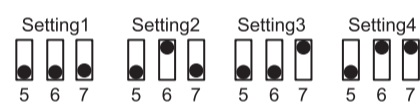

NOTE Make sure that dipswitch 5 is set to "OFF" for any setting.

3-3. Setting the Test input (SW1 Dipswitch 8)

Select "High" / "Low" for Test input. The delay time between Test input and Safety output is 10msec.

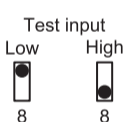

[2. Dipswitches <SW3>]

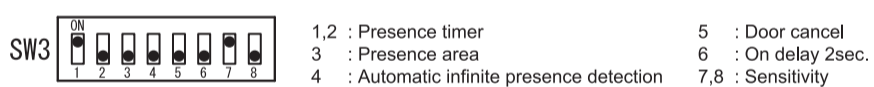

3-4. Setting the Presence timer (SW3 Dipswitch 1 and 2)

Presence detection timer can be selected by combining dipswitch 1 and 2.

NOTE To enable the presence detection, do not enter the detection area for 10 seconds after setting the timer.



3-5. Setting the Presence area (SW3 Dipswitch 3)

With dipswitch 3 "1st & 2nd", presence timer for 1st & 2nd rows belong to dipswitch 1 and 2. Presence timer for 3rd row automatically becomes 2 sec.. With dipswitch 3 "1st to 3rd", presence timer will be same as all detection area, set by combining dipswitch 1 and 2.

NOTE When dipswitch 4 is set to "ON" the automatic infinite presence detection has priority over this function.

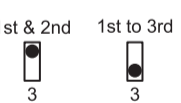

3-6. Setting the Automatic infinite presence detection (SW3 Dipswitch 4)

When people or objects enter more than 2 spot areas, this function automatically sets the presence timer to infinity to increase safety and avoid unwanted door opening due to sudden change in floor condition.

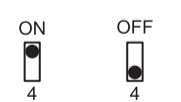

3-7. Setting the Door cancel (SW3 Dipswitch 5)

When dipswitch 5 is "ON" the sensor is less influenced by the door movement, i.e. caused by wind. If the sensor does not detect for 10sec., the 1st row will be disabled when door cancel function is "ON". (The 1st row will be enabled again when there is detection at other rows.)



WARNING Risk of getting caught. With this function, 1st row is disabled if there are no detection for 10sec. If a person or vehicle enter the first row without any detection in other rows (e.g. enter from the other side), it might cause an accident.

3-8. Setting the On delay 2sec. (SW3 Dipswitch 6)

To avoid unnecessary openings due to passing objects/persons set dipswitch 6 "ON". The sensor only activates when a person or object stays in the detection area for more than 2 seconds.

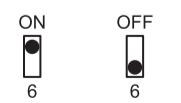

WARNING Risk of getting caught. Please do not set On delay 2sec. to "ON" when door cancel function is "ON". If both are "ON", the sensor does not output signal unless it detects a person or object more than 2sec and 1st row is inactive. If the person or object enter the first row, the sensor does not detect and door never opens.

3-9. Setting the Sensitivity (SW3 Dipswitch 7 and 8)

Recommended sensitivity setting in accordance with the following mounting height.

L (Low)	: 8'2"(2.5m) to 11'6"(3.5m)
M (Middle)	: 9'10"(3.0m) to 14'9"(4.5m)
H (High)	: 13'2"(4.0m) to 18'1"(5.5m)
S-High (Super high)	: 16'5"(5.0m) to 21'4"(6.5m)

NOTE Adjust the sensitivity to suit each installation site.

Checking

Check the operation according to the chart below.

		Power OFF	Outside of detection area	Entry into 3rd row	Entry into 2nd row	Entry into 1st row	Outside of detection area
Entry							
Status		-	Stand-by	Motion / Presence detection active	Motion / Presence detection active	Motion / Presence detection active	Stand-by
Image							
Operation indicator		None	Green	Orange	Orange	Red	Green
Dipswitches <SW1>	Simultaneous output OFF	2nd row output Activation	N.C. 1				
		Activation output	N.O. 1				
		2nd row output Safety	N.C. 2				
		Safety output	N.O. 2				
	Simultaneous output ON	Activation output	N.C. 1				
			N.O. 1				
		Safety output	N.C. 2				
			N.O. 2				

Inform building owner / operator of the following items

WARNING

- Do not wash the sensor with water.
- Do not disassemble, rebuild or repair the sensor yourself, otherwise electric shock may occur.

CAUTION

- Do not paint the detection window.

NOTE

- Always keep the detection window clean. If dirty, wipe the window with a damp cloth. (Do not use any cleaner / solvent.)
- When the operation indicator is twice green blinking, contact your installer or service engineer.
- Always contact your installer or service engineer when changing the settings.
- When turning the power ON, always walk-test the detection area to ensure the proper operation.
- Do not place any objects that move or emit light in the detection area. (e.g. Plant, illumination, etc.)

Alarm display

Refer to the **Troubleshooting** below when the following appears.

Status	Life cycle notification	Signal Saturation	Sensor failure
Operation indicator	Twice green blinking	Slow green blinking	Fast green blinking

NOTE LED will be turned off about 500ms when the sensor Test output signal works well.

Troubleshooting

Door operation	Operation indicator	Possible cause	Possible countermeasures
Door does not open when a person enters the detection area.	None	Wrong power supply voltage.	Set to the stated voltage.
	Unstable	Wrong wiring or connection failure.	Check the wires and connector.
		Wrong detection area positioning.	Check Detection area & Adjustments
		Sensitivity is too low.	Set the sensitivity higher.
Door opens when no one is in the detection area. (Ghosting)	Green	Wrong (Safety/Activation) output setting.	Check Adjustments 3-1 .
	Orange	Both On delay and door cancel function are "ON".	Set either function to "OFF"
		Wrong wiring.	Check the wires and connector.
		Wrong (Safety/Activation) output setting.	Check Adjustments 3-1 .
Door remains open	Proper	Presence timer is "∞" and sudden change in the detection area happened.	Check Adjustments 3-4 & 3-6 . If the problem still persists, hard-reset the sensor. (Turn the power OFF and ON again.)
	Green	Wrong wiring or connection failure.	Check the wires and connector.
		The automatic infinite presence detection is "ON" and the objects or people enter more than two spot areas.	Remove the objects. Or check Adjustments 3-6 .
Proper	Twice green blinking	Output relay(s) is reaching the end of its life cycle.	Replace the sensor.
	Slow green blinking	Signal saturation	Remove highly reflecting objects from the detection area. Change the area angle.
		The detection area overlaps with the door / header.	Adjust the detection area to "Deep" (Outside).
	Fast green blinking	Sensitivity is too low.	Set the sensitivity higher.
Sensor failure	Dirty detection window.	Wipe the detection window with a damp cloth. (Do not use any cleaner or solvent.)	
	Sensor failure	Contact your installer or service engineer.	

Manufacturer

OPTEX Co.,LTD.
5-8-12 Ogoto Otsu 520-0101, Japan
TEL.: +81(0)77 579 8700 FAX.: +81(0)77 579 7030
WEBSITE: www.optex.net

European Subsidiary

OPTEX Technologies B.V.
Henricuskade 17, 2497 NB The Hague, The Netherlands
TEL.: +31(0)70 419 41 00 FAX.: +31(0)70 317 73 21
E-MAIL: info@optex.eu WEBSITE: www.optex.eu

North and South America Subsidiary

OPTEX INCORPORATED
18730 S. Wilmington Avenue, Suite 100 Rancho Dominguez CA 90220 U.S.A.
TEL.: +1-800-877-6656 FAX.: +1(310)898-1098
WEBSITE: www.ot-inc.com

East coast office

8510 McAlpines Park Drive, Suite 108
Charlotte, NC 28211 U.S.A.
TEL.: +1-800-877-6656 FAX.: +1(704)365-0818
WEBSITE: www.ot-inc.com